

Double Truss Building

Model# SST336017

33'x60'x17'

W10.0x L18.0 x H5.2m

Assembly Instructions

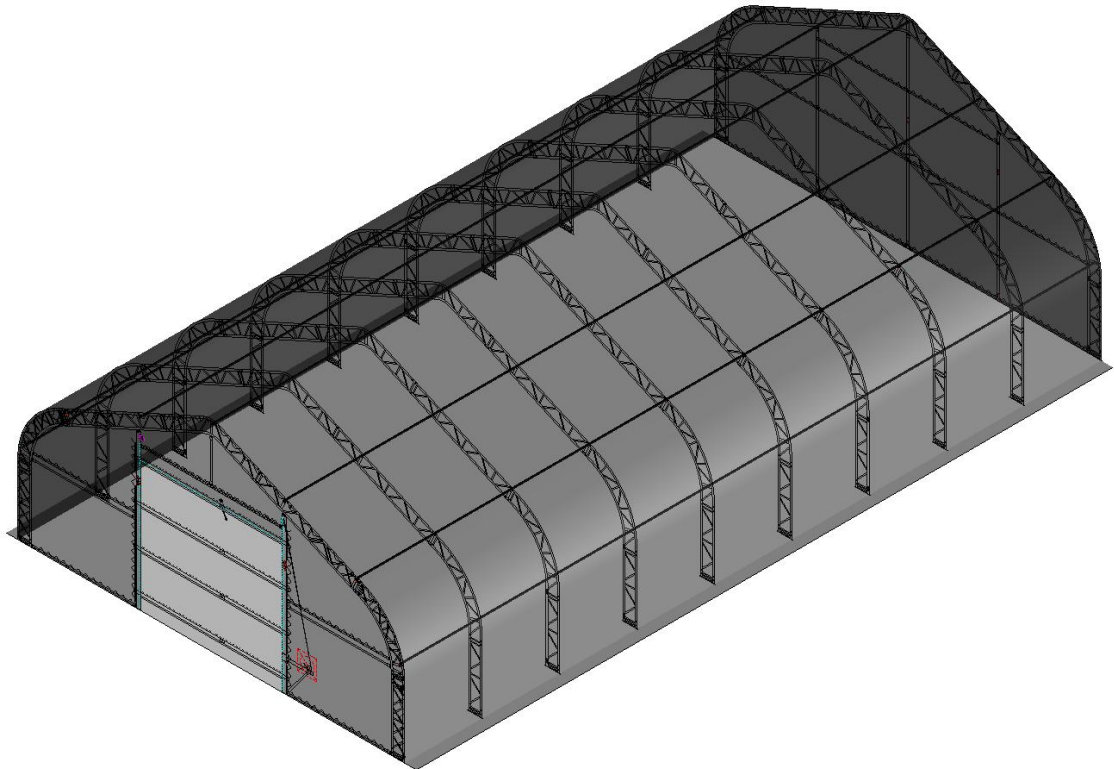

RECOMMENDED TOOLS

Equipment List	
Speed Wrench 22#.23#.24#	
Hammer (30lb)	
Rope (12#)	
Long Tape (50m)	
Hammer Drill*1	
Lifter*2	
Crane*1	
Forklift*1	
Protective equipment	

YOU MUST READ THIS DOCUMENT BEFORE YOU BEGIN TO ASSEMBLE THE SHELTER.

Thank you for purchasing our shelter. When properly assembled and maintained, this product will provide years of reliable service. These instructions include helpful hints and important information needed to safely assemble and properly maintain the shelter. Please read these instructions **before** you begin.

If you have any questions during the assembly, please contact local dealer for assistance.

SAFETY PRECAUTIONS

- . Wear eye protection.
- . Wear head protection
- . Wear gloves when handling metal tubes
- . Use a portable GFCI (Ground Fault Circuit Interrupter) when working with power tools and cords.
- . Do not climb on the shelter or framing during or after construction.
- . Do not occupy the shelter during high winds, tornadoes, or hurricanes.
- . Provide adequate ventilation if the structure is enclosed.
- . Do not store hazardous materials in the shelter.
- . Provide proper ingress and egress to prevent entrapment.

ANCHORING INSTRUCTIONS

Prior to assembling this shelter, please read the **MUST READ** document included with the shipment.

⚠ WARNING: The anchor assembly is an integral part of the shelter construction. Improper anchoring may cause shelter instability and failure of the structure. Failing to anchor the shelter properly **will void the manufacturer's warranty** and may cause serious injury and damage.

LOCATION

Choosing the proper location is an important step before you begin to assemble the structure.

The following suggestions and precautions will help you determine whether your selected location is the best location.

- . Never erect the structure under power lines.
- . Identify whether underground cables and pipes are present **before** preparing the site or anchoring the structure.
- . Location should be away from structures that could cause snow to drift on or around the building
- . Do not position the shelter where large loads such as snow and ice, large tree branches, or other overhead obstacles could fall.
- . Your shelter's cover can be quickly removed and stored prior to severe weather conditions. If strong winds or severe weather is forecast in your area, we recommend removal of cover.

SITE







After choosing a location, proper preparation of the site is essential. The following site characteristics will help ensure the integrity of the structure.





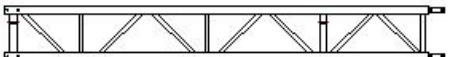
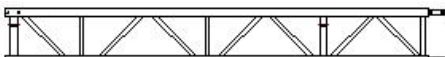
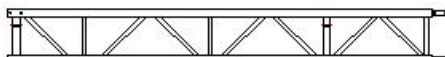

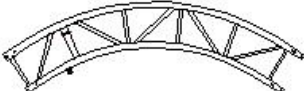
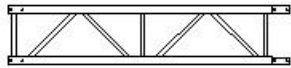
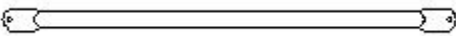

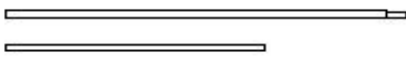
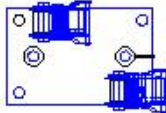



- . The support structure must be level to properly and safely erect and anchor the frame.
- . Drainage: Water draining off the structure and from areas surrounding the site should drain away from the site to prevent damage to the site, the structure, and contents of the structure.

⚠ WARNING: The individuals assembling this structure are responsible for designing and furnishing all temporary bracing, shoring and support needed during the assembly process. For safety reasons, those who are not familiar with recognized construction methods and techniques **must seek the help of a qualified contractor.**



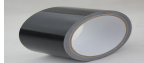

Double Truss Building SST336017 (W10xL18xH5.2m) with mechanical door W3.66xH3.36m on one end











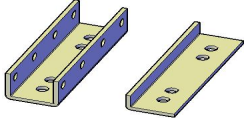

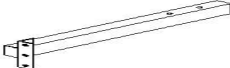

Parts List

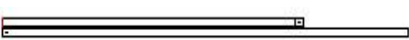
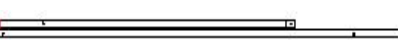







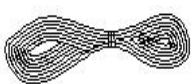



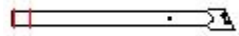

Part Code	Description	Qty/ pcs	Box
1	top truss for 2nd to 9th arch		8 A
1A	top truss for 1st arch		1 A
1B	top truss for 10th arch		1 A
2	roof truss for 2nd to 9th arch		16 A
2A	roof truss for 1st arch		2 A
2B	roof truss for 10th arch		2 A
3	shoulder truss for 2nd to 9th arch		16 A
3A	shoulder truss for 1st and 10th arch		4 A
4	upright truss for 1st to 10th arch		20 B
5	purlin		63 B
6	connection plate for steel wire No.21		48 B
7	tensioning tube for roof cover, (6+1) pcs/set		2 sets A
8	corner base plate (left & right) for 1st and 10th arch, installed with ratchet		4 B

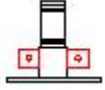
9	interior base plate for 2nd to 9th arch, installed with ratchet		16	A
10	tube clip for steel wire No.21		96	B
11	bolt M8x60 for truss swaged end connection		320	B
12	bolt M10x70 for purlin connection		70	B
13	end plug (Φ32) for tensioning tube No.7		4	B
14	belt for ratchet on base plate		20	B
15	rope for roof cover, 4 bundles		1 pack	B
16	roof cover		1	B
17	duct tape		5	B
18	expansion bolt		80	B
19	steel wire turnbuckle		48	B
20	steel wire clamp		96	B
21	steel wire between arches		48	B

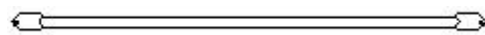
Front Wall with Mechanical Door W3.66xH3.36m

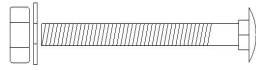
22	square tube post on the lower left side of the front door		1	A
23	square tube post on the lower right side of the front door		1	A
24	square tube post on the upper left side of the front door		1	A
25	square tube post on the upper right side of the front door		1	A

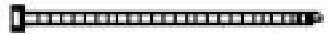
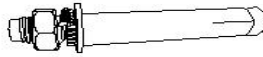
26	connection plate for square tube post No.22, 23, 24, 25, (1+1) pcs/set		2 sets	A
27	cross beam for front door, (1+1) pcs/set		1 set	A
28	vertical tube for door beam No.27		1	A
29	upper rail for front wall		2	A
30	lower rail for front wall		2	A
31	front door winch bracket		1	A
32	support tube for winch bracket		1	A
33	pole for door opening		1	A
34	door bracing tube, (1+1) pcs/set		3 sets	A
35	bottom bracing tube with hole, (1+1) pcs/set		1 set	A
36	bolt M10x30 for rail and connection plate		14	B
37	bolt M10x50 for post and truss		4	B
38	bolt M6x40 for door bracing tube No.34, No.35		4	B
39	bolt M12x130 for square tube post No.22, 23, 24, 25		10	B
40	bolt M10x70 for square tube post No.22, 23, 24, 25		9	B
41	rope for front cover,3 bundles		1 pack	B
42	cable tie for fixing front cover		50	B
43	expansion bolt		8	B
44	steel wire for front door		1 bundle	B

45	steel wire clamp		4	B
46	door winch		1	B
47	front cover		1	B
Back Wall				
48	post for back wall		3	A
49	post for back wall		2	A
50	post for back wall		1	A
51	base plate for back wall		3	A
52	rail for back wall		2	A
53	rail for back wall		4	A
54	rail for back wall		4	A
55	bolt M10x30 for rail and connection plate		16	B
56	bolt M8x70 for swaged tube		12	B
57	carriage bolt M10x80 for post and rail		6	B
58	rope for back cover, 3 bundles		1 pack	B
59	cable tie for fixing back cover		50	B
60	expansion bolt		6	B
61	back cover		1	B

INSTALLATION PROCESS

A—BASE PLATES INSTALLATION

Please refer to the below diagram to mark the position of base plate.

The measurement is from center to center of base plates. Referring to the diagram and confirm the place of base plates. ENSURE THAT THE FOUNDATION IS SQUARE.

Note: The expansion bolt (No.18, No.43, No.60) applies for fixing base plate on concrete ground.

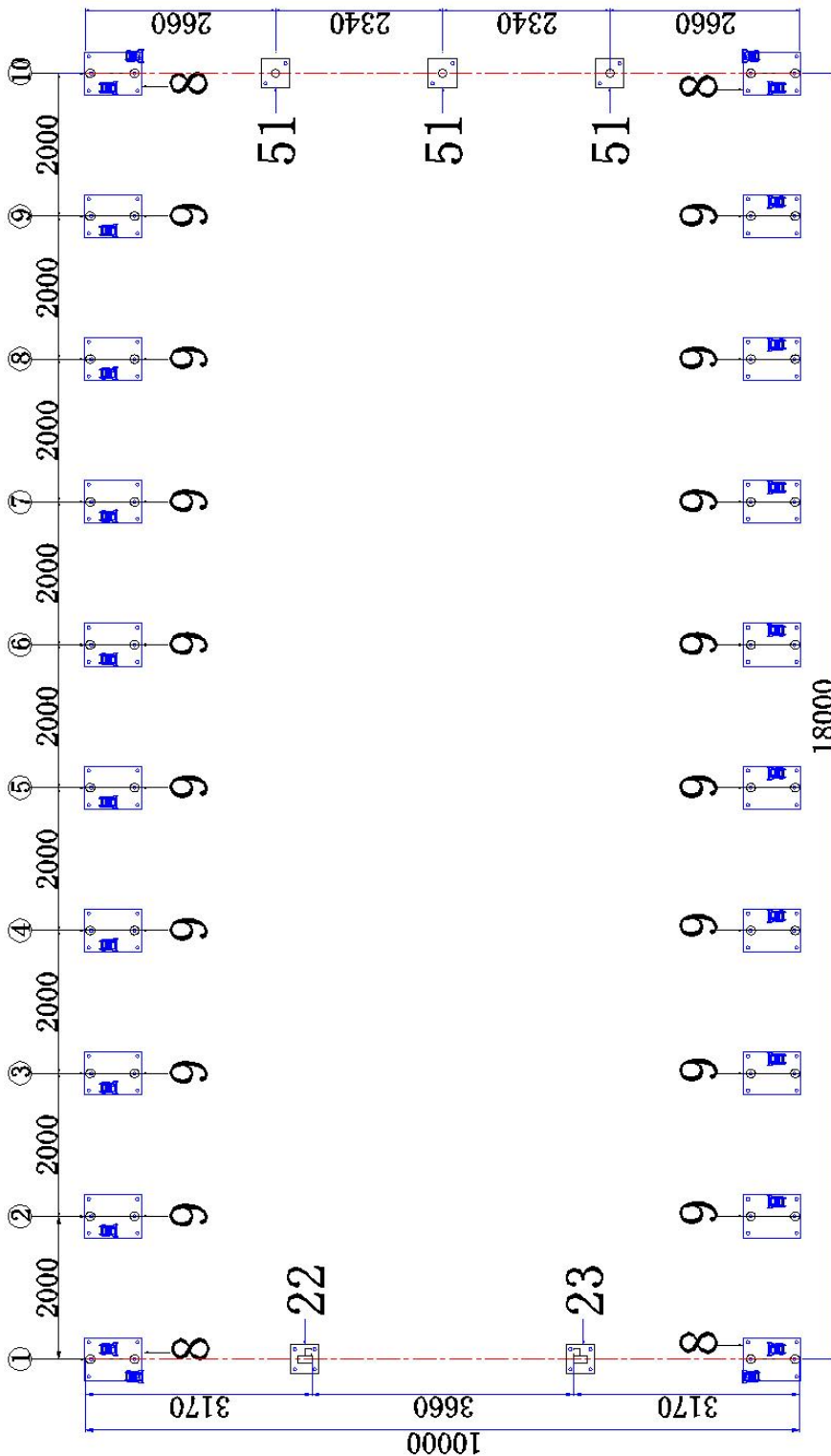

B—FRAME INSTALLATION

First Arch and Front Wall

1. Find Trusses (No.1A, 2A, 3A, 4) for first arch and connect them by bolt M8x60 (No.11).
2. Find relative parts of posts and rails for front wall and assemble them according to the below diagram.

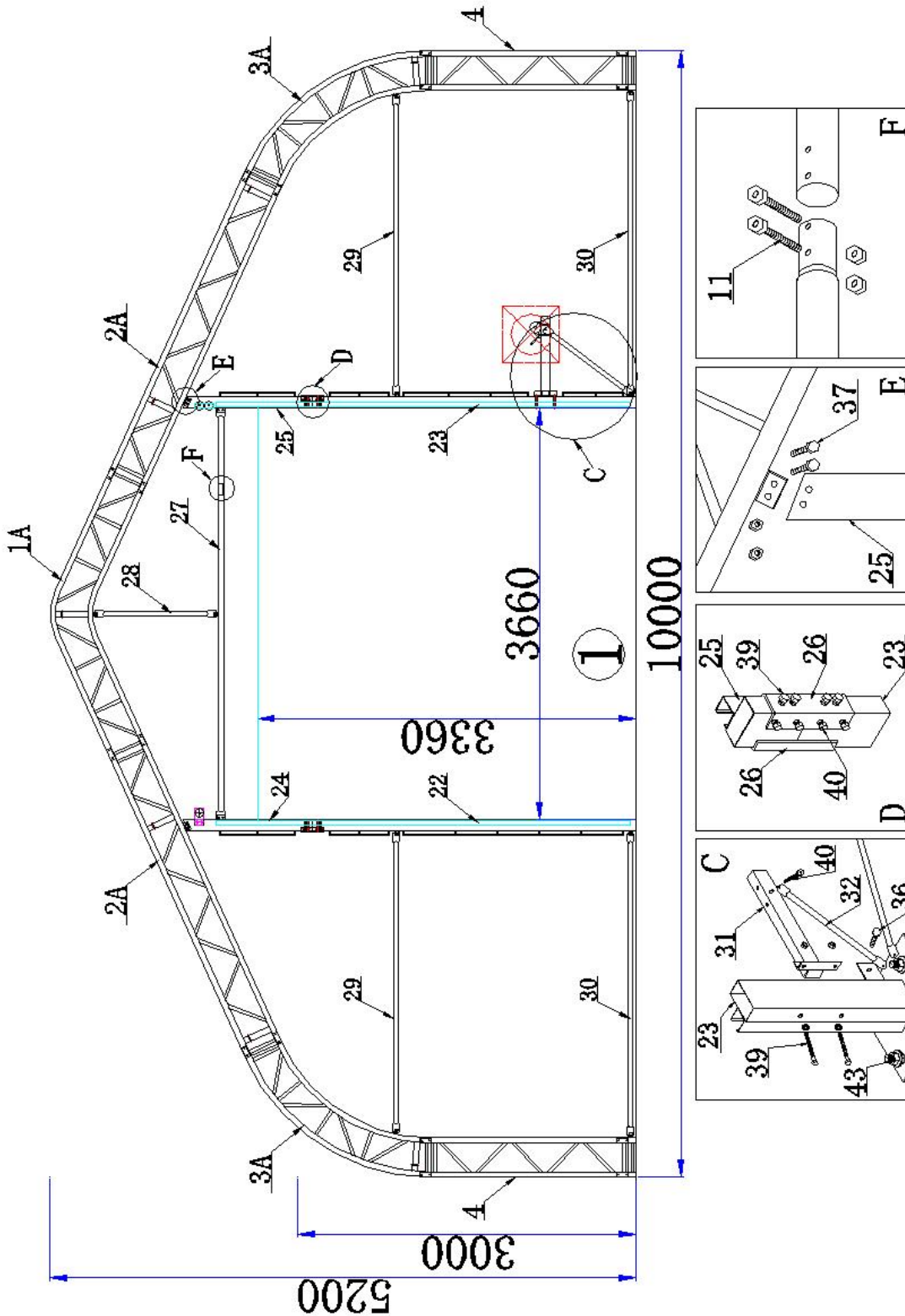

Second Arch to Ninth Arch Installation

3. Find Trusses (No.1, 2, 3 and 4) for second to ninth arch and connect them by bolt M8x60 (No.11).

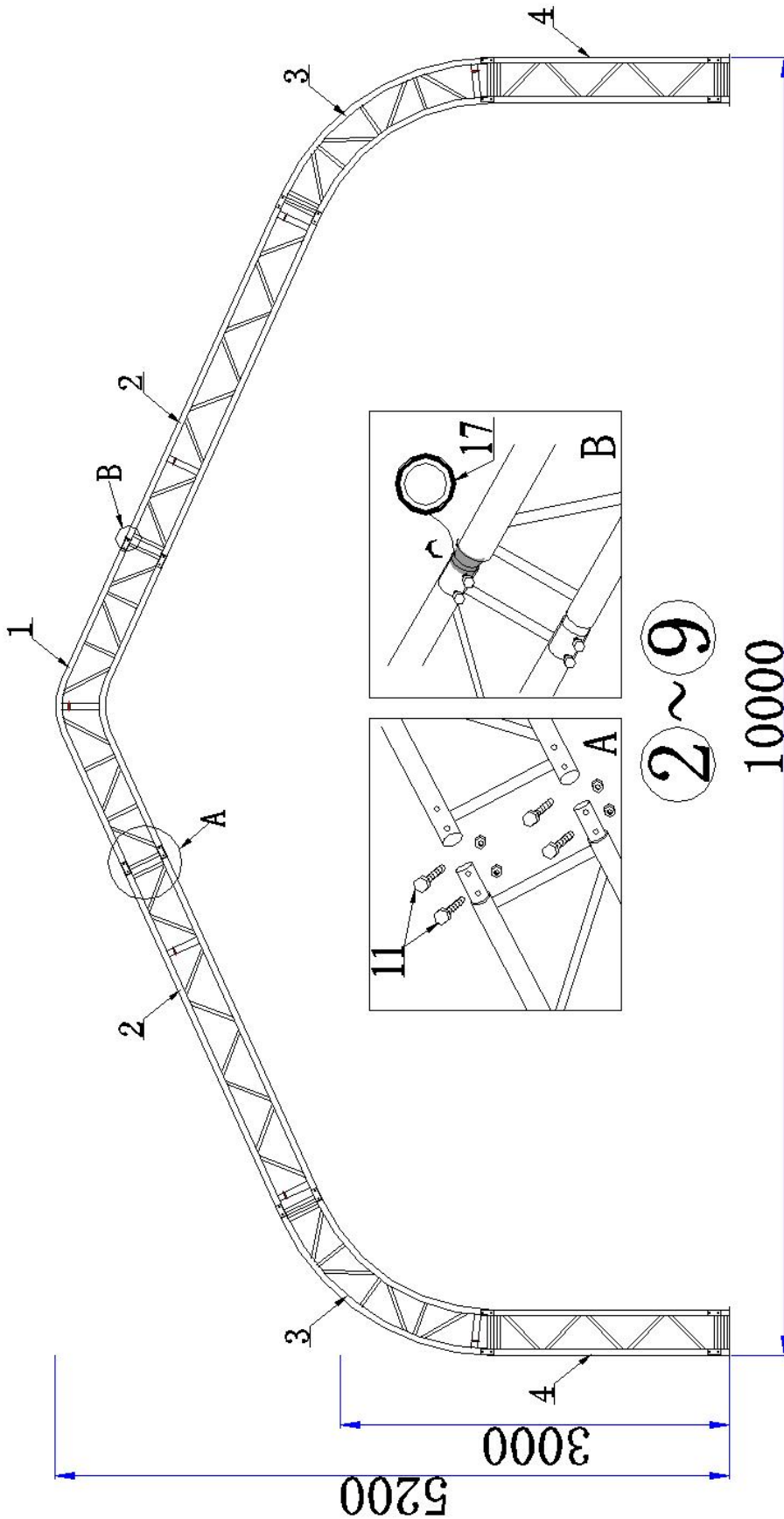

Tenth Arch and Back Wall

- Find Trusses (No.1B, 2B, 3A, 4) for tenth arch and connect them by bolt M8x60 (No.11).
- Find relative parts of posts and rails for back wall and assemble them according to the below diagram.

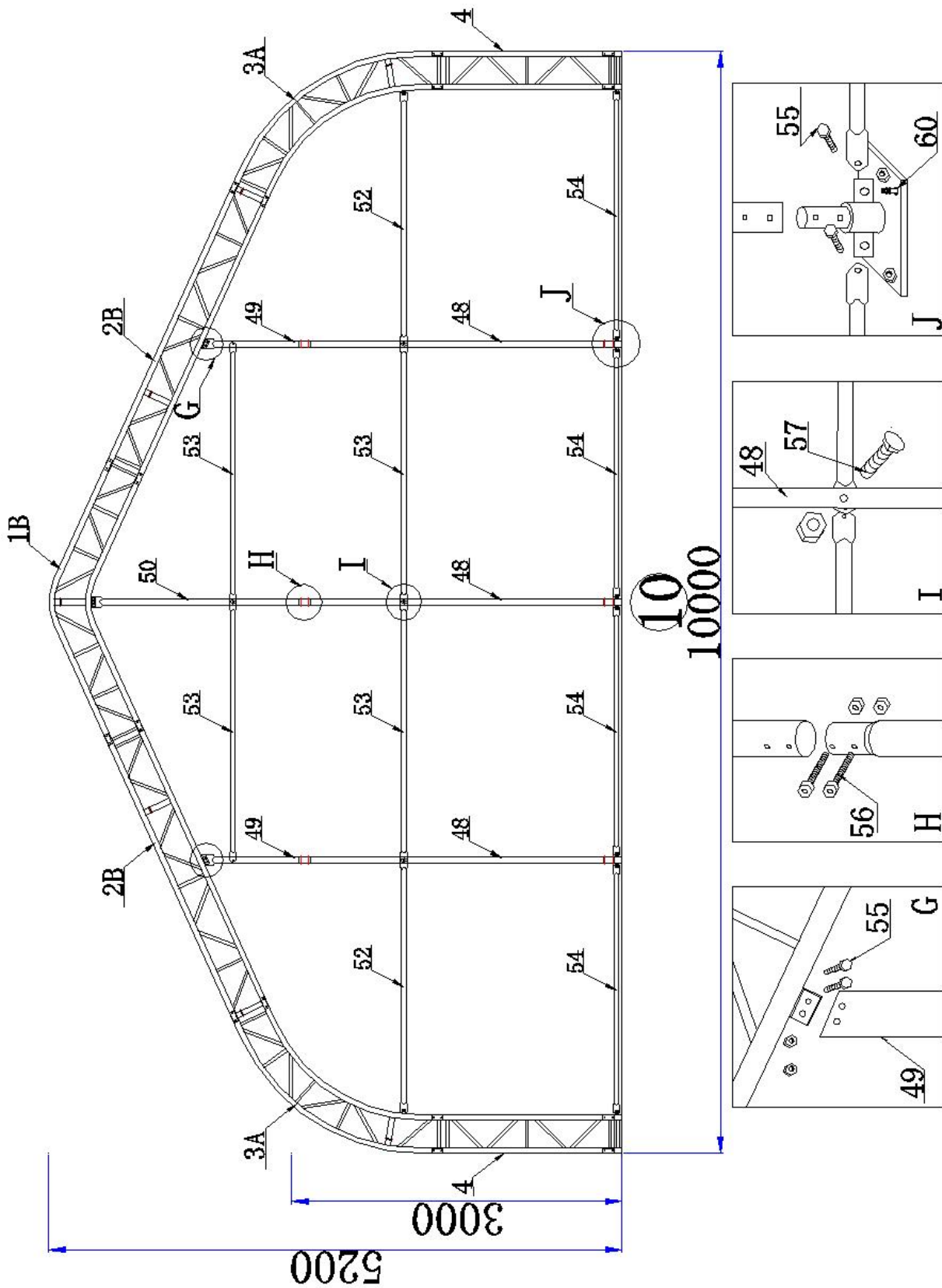

Purlin and Steel Wire Installation

6. Lift the assembled arches onto base plates (No.8 and No.9) and connect them by bolt M8x60 (No.11).
7. When finish installing the first and second arches, install purlin (No.5) and connect them by bolt M10x70 (No.12). Then the third arch and purlins. In this turn, one arch and then purlin tubes until the tenth arch.
8. Install steel wires (No.21 & No.21A) between arches by steel wire turnbuckle (No.19), steel wire clamp (No.20), connection plate (No.6) and tube clip (No.10).
9. Wrap every truss joint by duct tape (No.17) to protect roof cover.

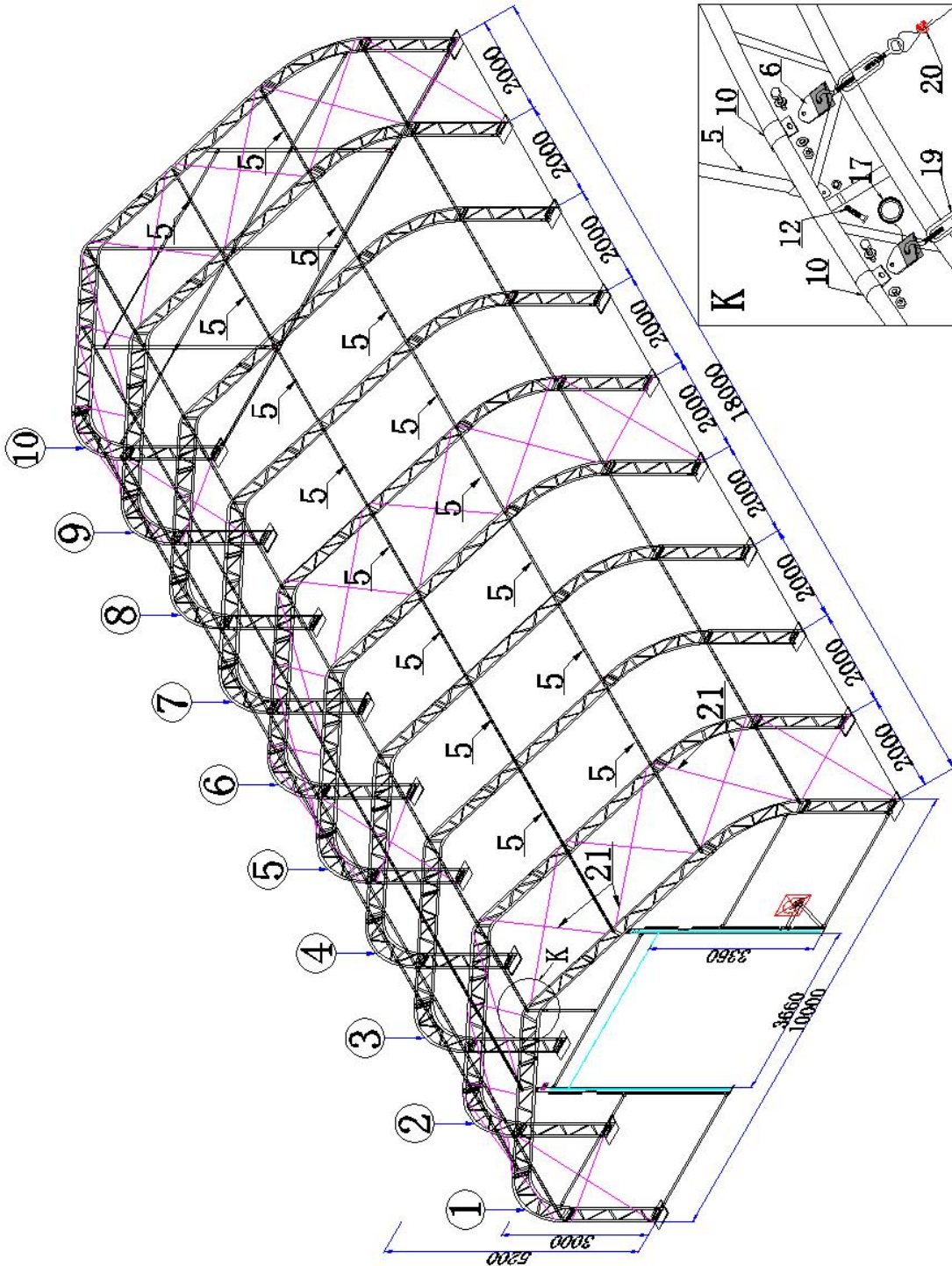

C-INSTALLING COVER

Front Cover and Mechanical Door Installation

Install the mechanical door refer to the diagram bellow.

Mechanical Door Installation

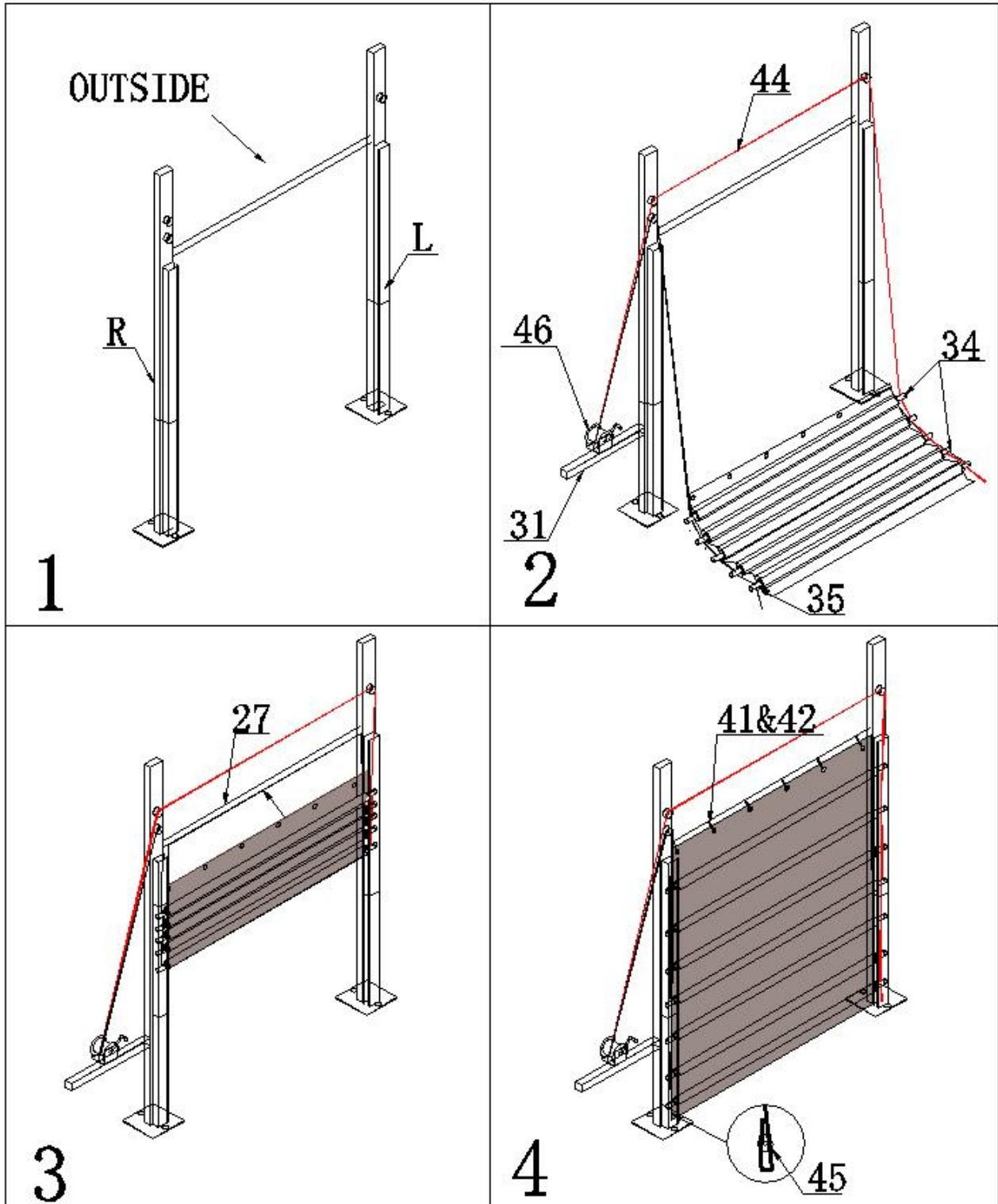

1. Install the front door frame and door winch bracket
2. Fix the winch to the bracket. Make sure the winch handle faces the outside. Refer to Figure 1.

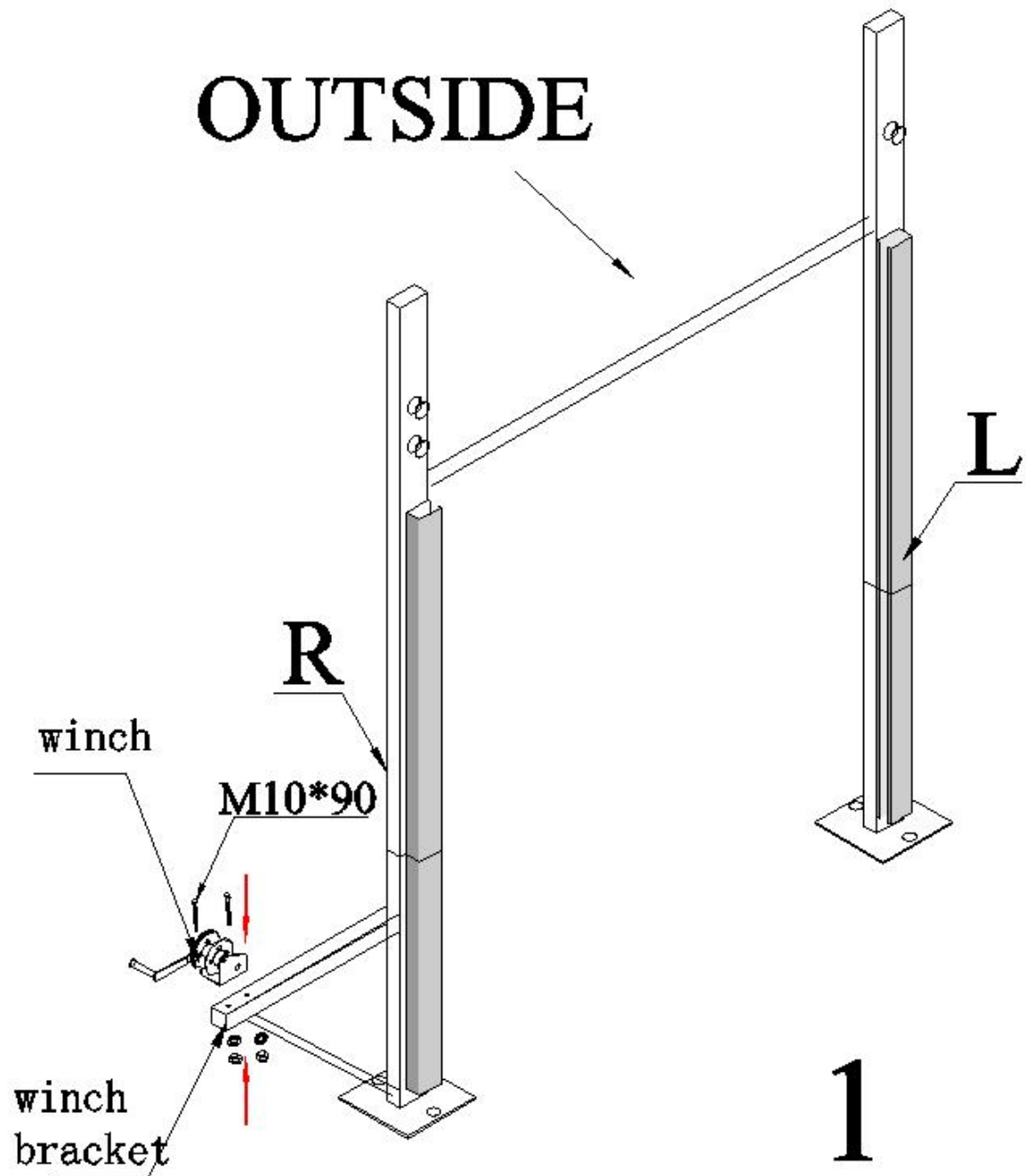

3. Take out the door curtain cloth and lay it on the ground. Pay attention to the direction. The side with pipe pockets faces inward.

4. Connect the door bracing tube (2pcs/set) with M6x40 bolt.

5. Thread the door bracing tube into the pocket from top to bottom. Pay attention to the bottom bracing tube. There are holes on both sides for fixing steel wire rope. Refer to Figure 2.

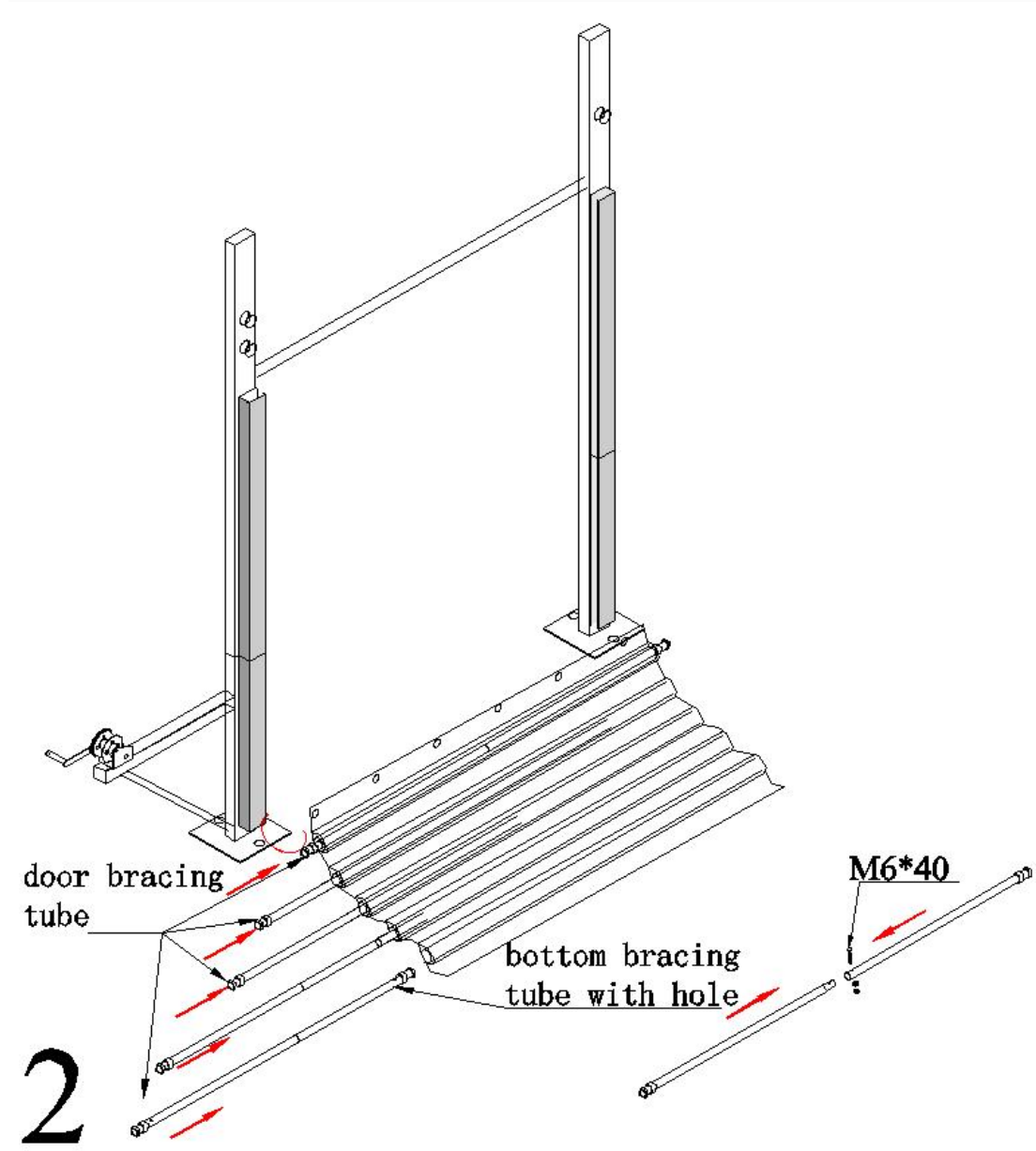

6. Put the steel wire rope through the pulley on the door frame as shown in Figure 3, so that the steel wire rope is located on the inner side of the door frame and on the same plane as the pulley, and then the steel wire rope sags naturally. Keep the length of both sides equal, and naturally sag to the ground.
7. Fix each end of steel wire rope to the hole on bottom bracing tube with steel wire clamps. Make sure fix it firmly.
8. Put the door bracing tube into the track from the gap at the bottom, from top to bottom.

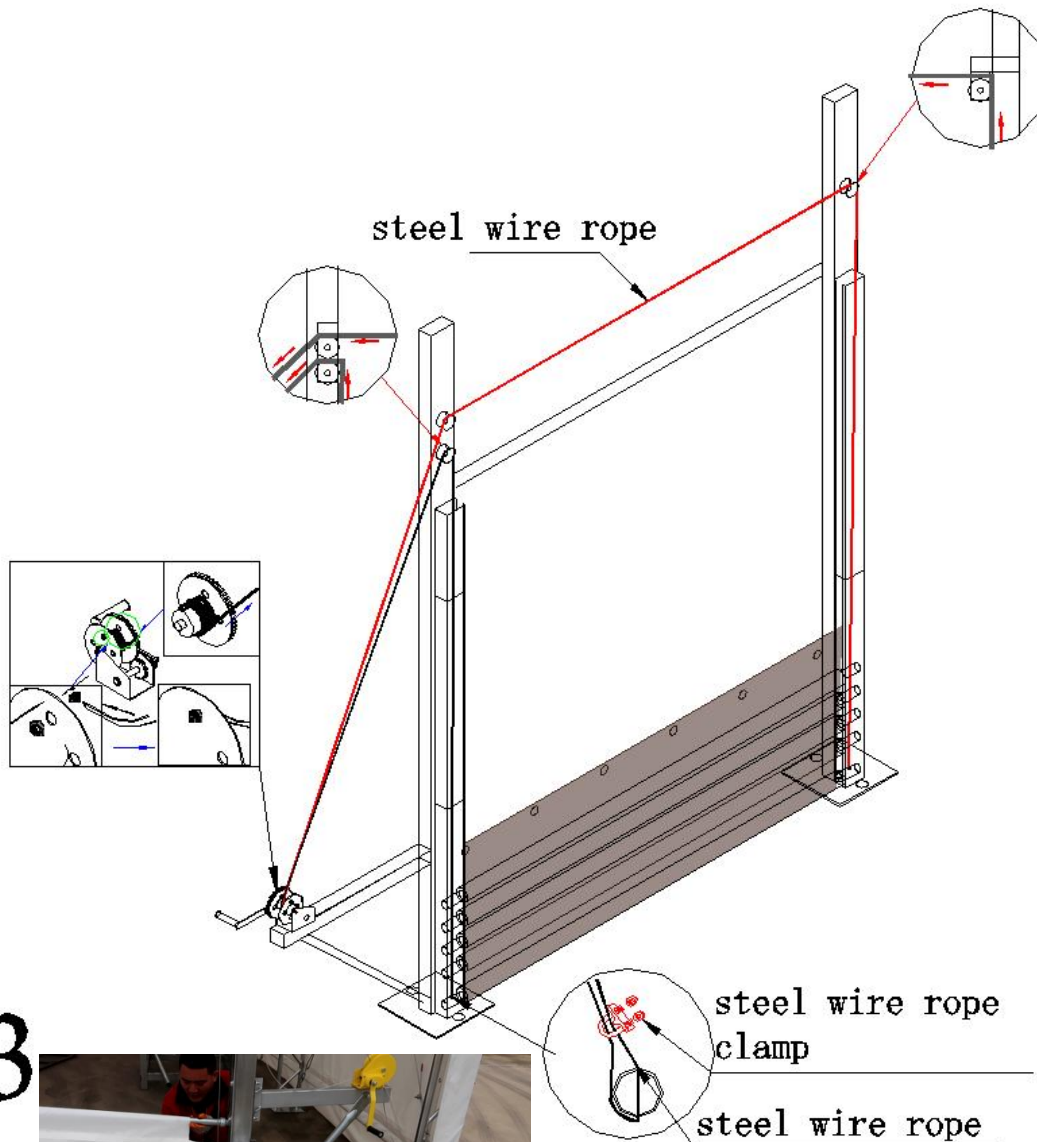

3



9. Adjust the length of the steel wire rope to be equal on both sides. Fix the wire rope fold to the hole in the winch. Refer to Figure 4.

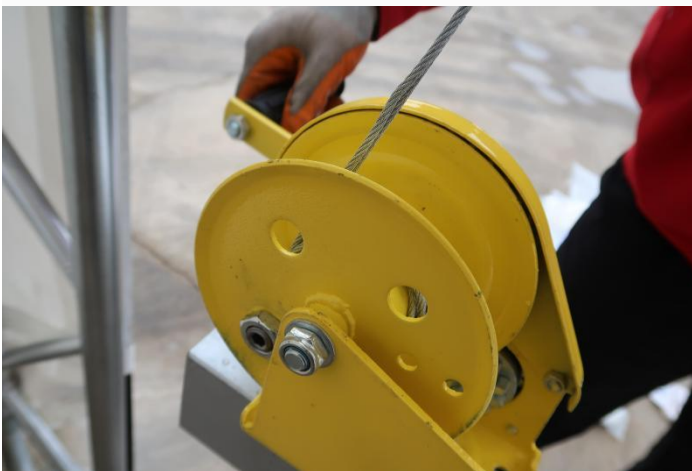
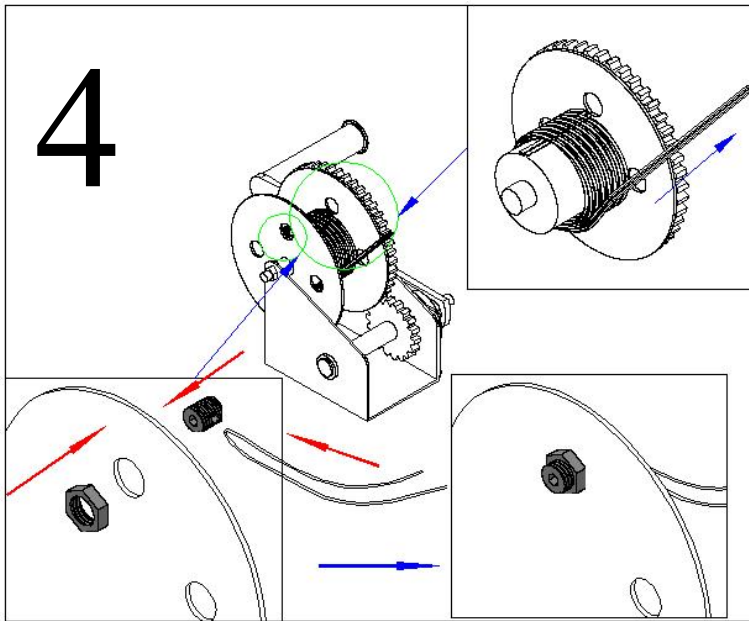

10. Turn the winch clockwise to lift the door curtain cloth and bracing tubes to a position about 40-50cm away from the cross beam. Lace the eyelets on the cloth to cross beam with a rope. Refer to Figure 5.

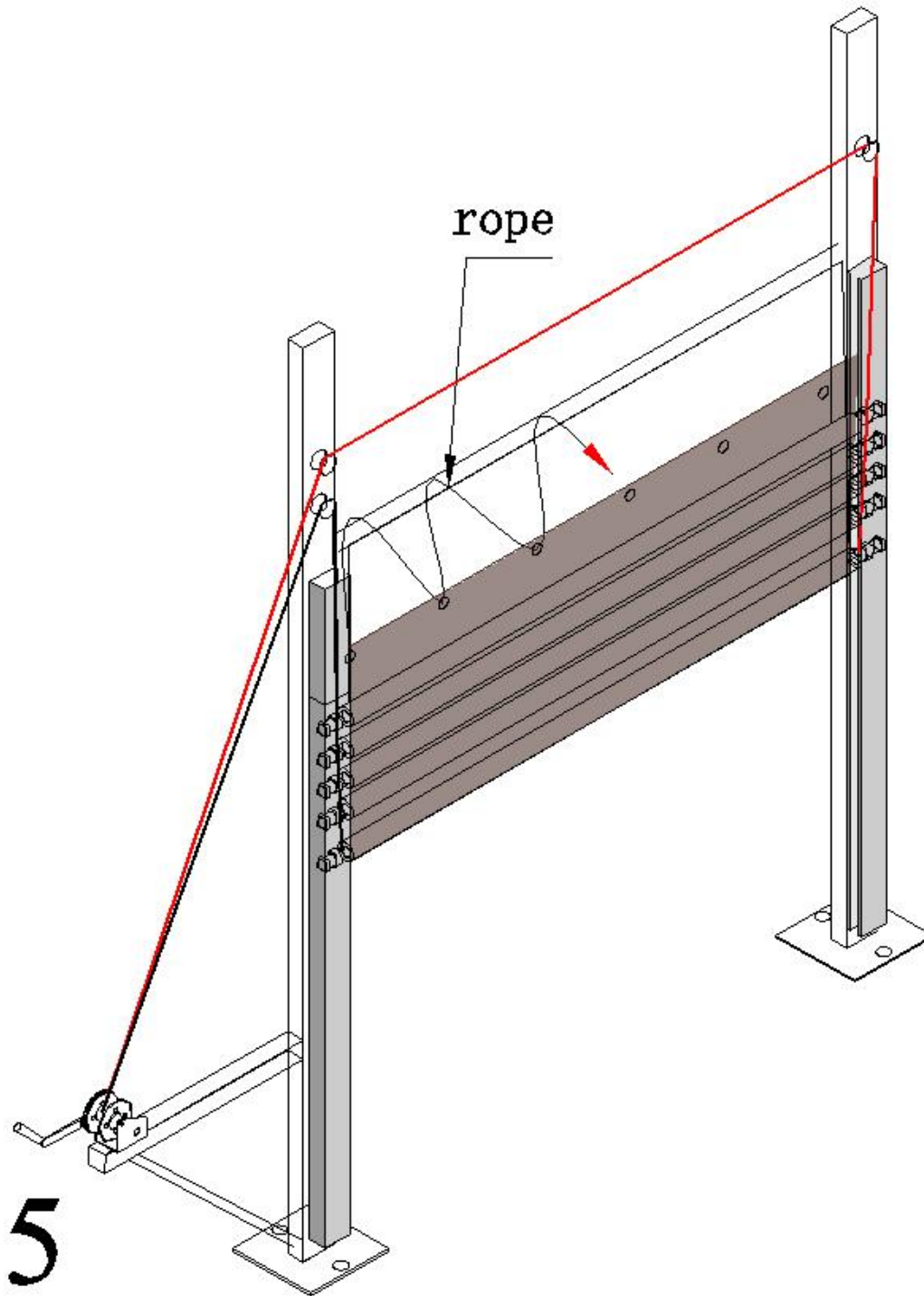

11. Now the winch door installation is completed. Turn the winch clockwise to raise and counterclockwise to lower the door. The steel wire rope shall be evenly wound on the winch so that the door can rise and fall smoothly.

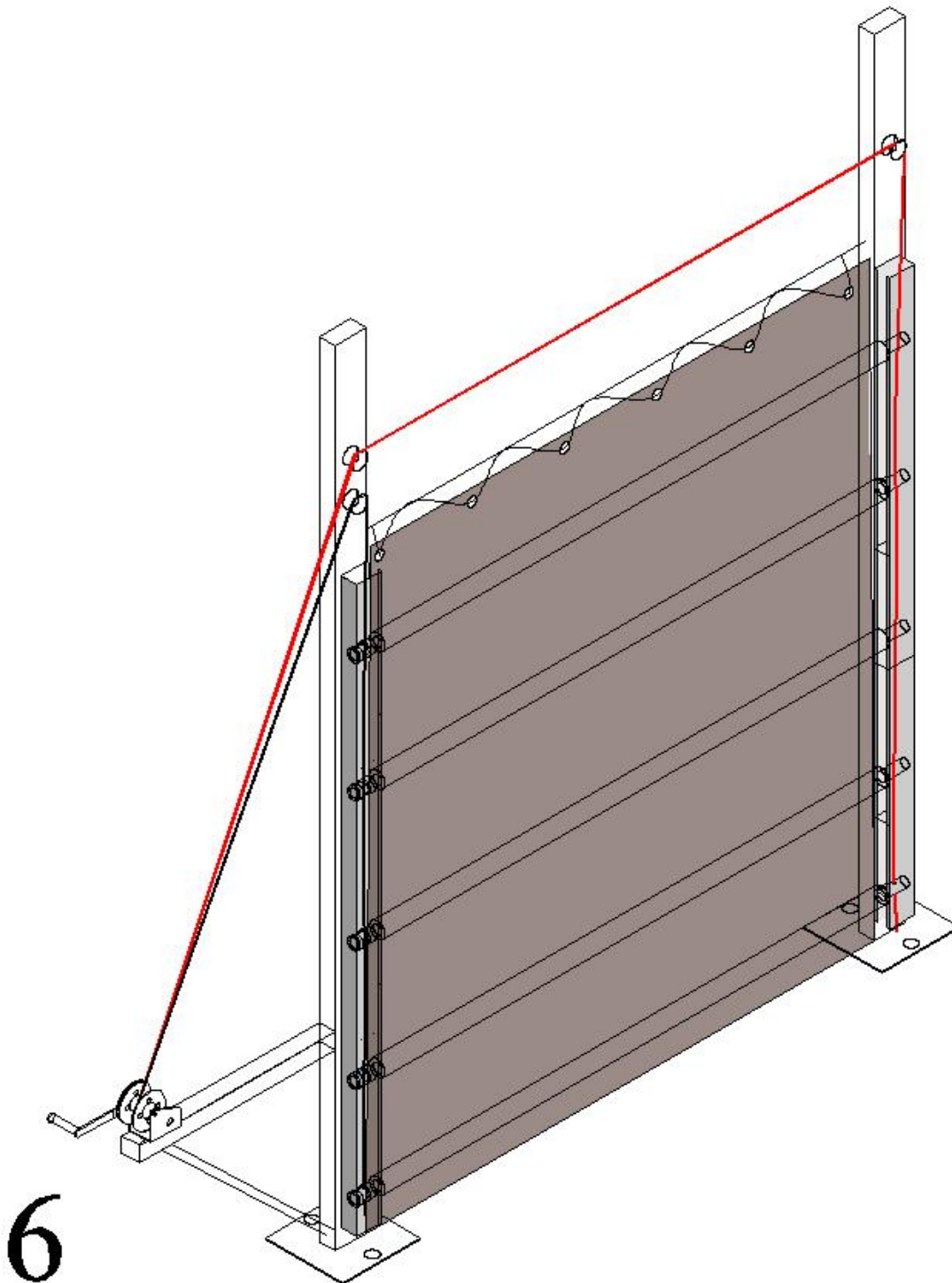

Front Cover Installation

Install front cover (No.47) to the first arch and posts and rails on front wall with rope (No.41) and cable tie (No.42).

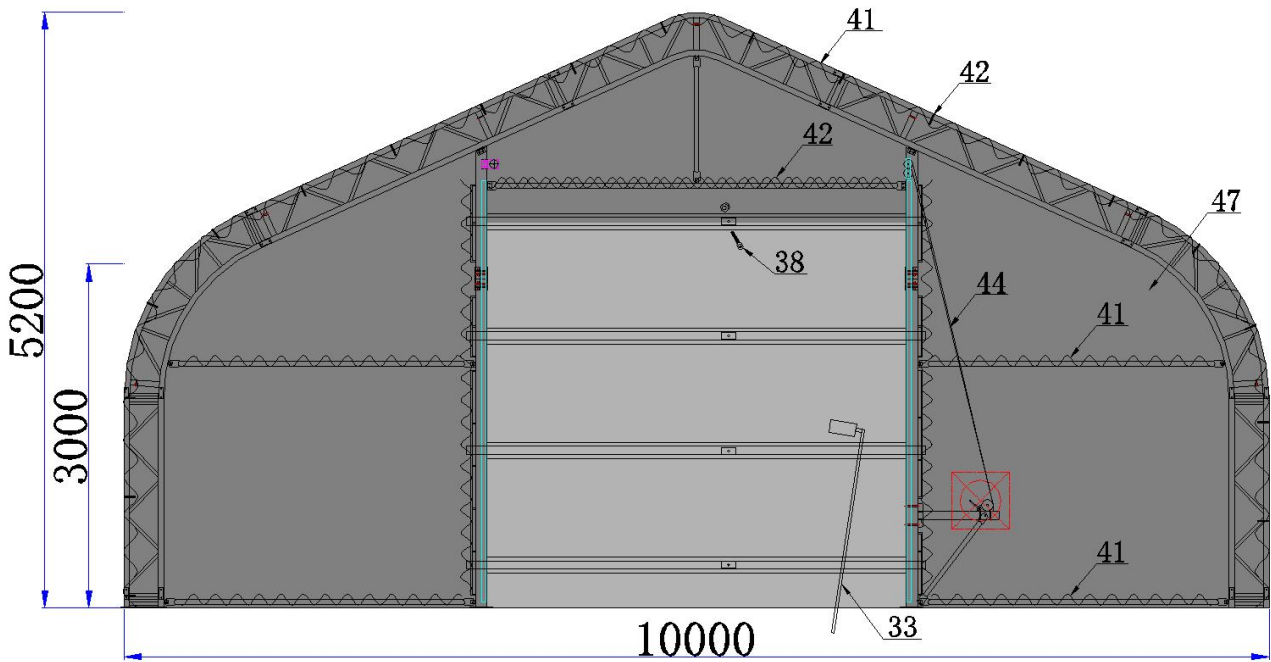

Back Cover Installation

Install front cover (No.61) to the tenth arch and posts and rails on back wall with rope (No.58) and cable tie (No.59).

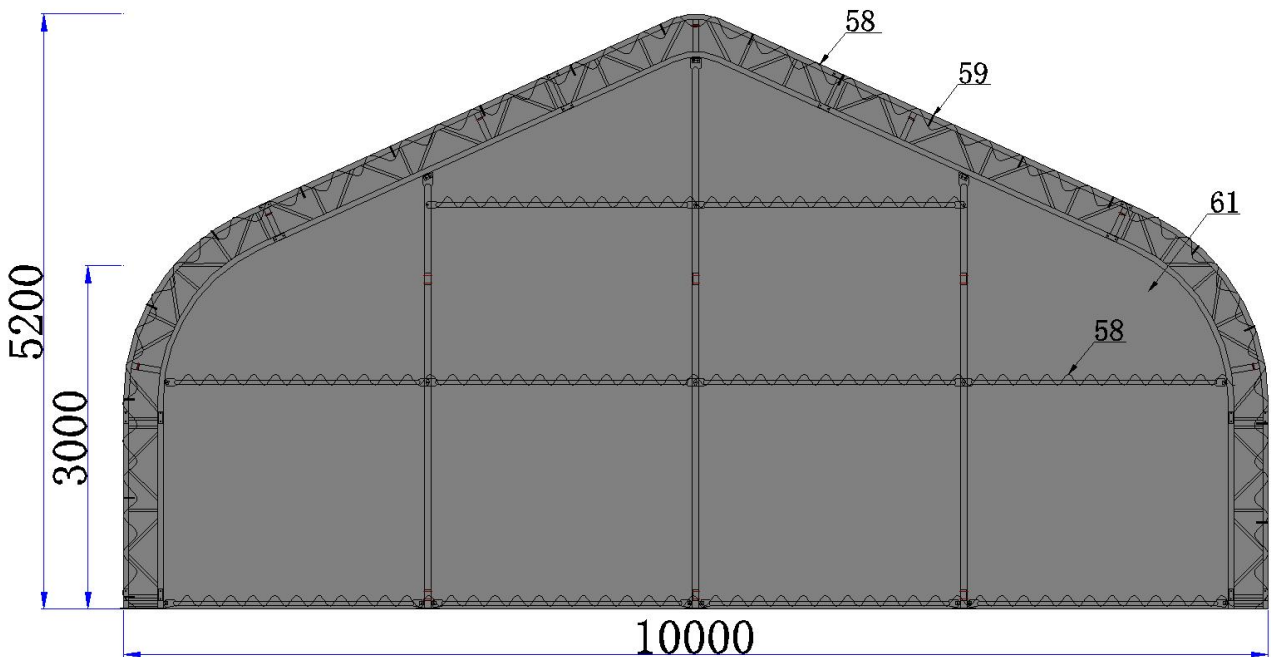

Roof Cover Installation

NOTE: DO NOT install the cover onto the frame of your building in high wind conditions. A slight breeze is the most advantageous for cover installation. To take advantage of the breeze, pull the cover up over the arches with the breeze blowing in the cover like a sail filled with air.

1. Roll out the roof cover on a ground sheet. Align the cover evenly to each end of the frame. Be sure doing not over pull the end of roof cover.
2. Pull the roof cover over frame **EVENLY, CAREFULLY AND SLOWLY**. Insert tensioning tube (No.7) into the pipe pockets. Cut a small opening over against every base plate. Put the belt (No.14) around tensioning tube and go through ratchet on base plate and loosely secure. **DO NOT TIGHTEN**. Adjust the cover so that it is square and evenly centered on the frame.

Note: The end flaps must overhang evenly at both ends.

3. Use Rope (No.15) to tighten roof cover to end arches.
4. When roof cover is tidy and ready, drive the ratchet tie down forth and back and then roof cover is tightened in the vertical direction.
5. Tidy the cover. Pull the strap inside the end of roof cover, make the cover well fold to end arches and fasten the strap with ratchet.

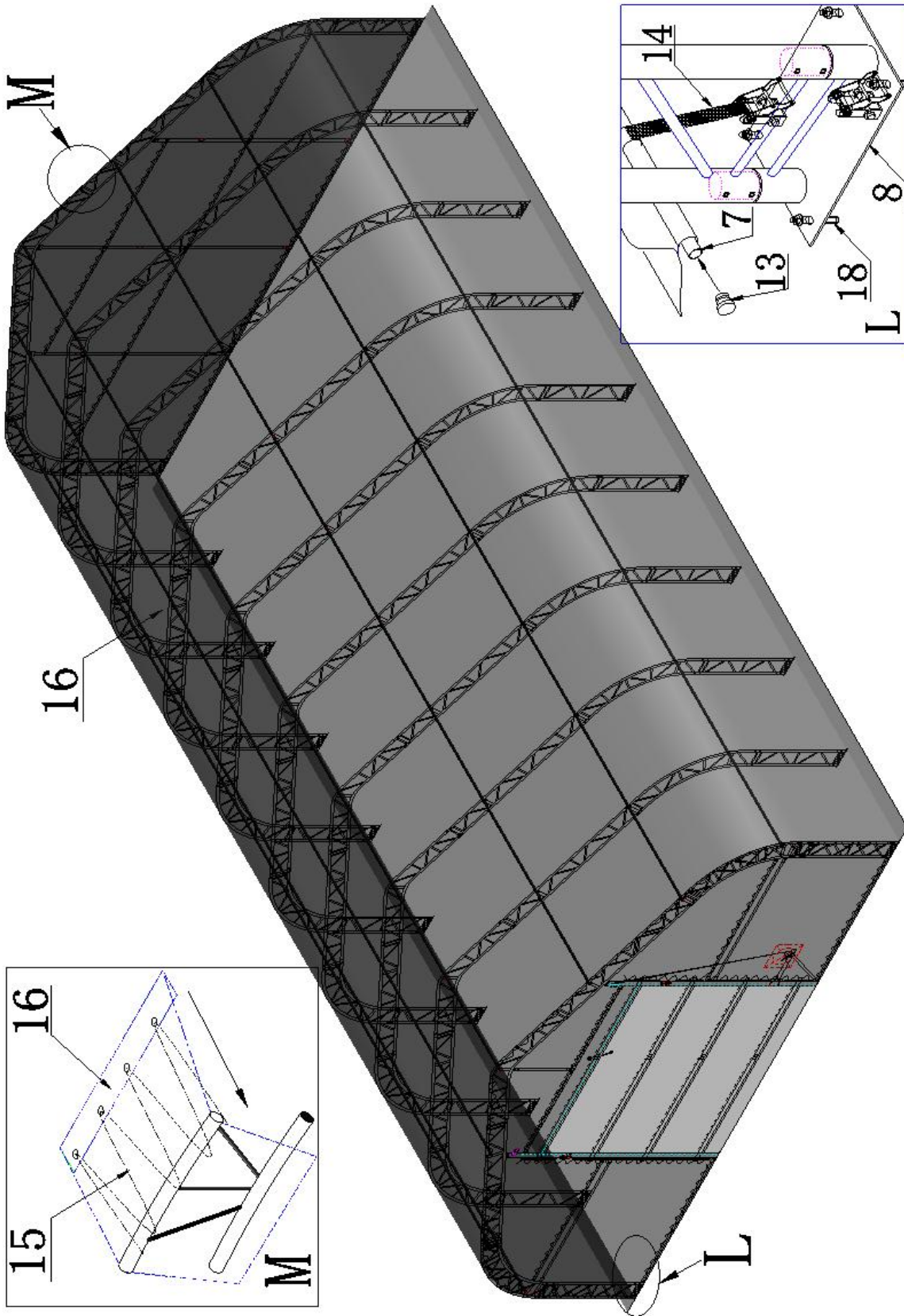

Now your assembly is completed