

DALA-GRIPEN



sitRIGHT

— NUMBER ONE IN THE FOREST —

DALA-GRIPEN GRAPPLES IDEAL FOR USE ON FORWARDERS, TRUCKS AND EXCAVATORS WORLDWIDE.

BEING NR1 IN THE FOREST, WE OFFER A WIDE RANGE OF TOP-QUALITY PRODUCTS TO MAKE YOUR WORK MORE EFFICIENT AND EASY.

DALA-GRIPEN REPRESENTS VARIETY OF GRAPPLES FOR BOTH FORESTRY, CONSTRUCTION AND RECYCLING.

All DALA –GRIPPEN products are supplied with product passport that includes spareparts catalogue as well as technical information about maintenance and usage. You will also find safety instructions and warranty conditions in there.



ENTREPRENADGRIPAR
HEAVY DUTY GRAPPLES



STEN/SORTERINGSGRIPAR
STONE/RECYCLINGS GRABS



MULTIGRIPAR
MULTI GRABS



TIMMERGRIPAR
LOG GRAPPLES



RISGRIPAR FOREST
RESIDUE GRAPPLES



SKOPOR
CLAMSHELL BUCKETS



ENERGI KLIPP
ENERGY WOOD GRAPPLES



FÄSTEN
ADAPTERS

Note! The manufacturer reserves the right to make changes in technical specifications.

Heavy Duty timber grapple for real challenges, also perfect for tiltrotor use with universal quick hitches. Heavy duty grapple is suited for heavy forest works, different waste sorting and pipe/round wood loading or moving and industrial loadings.

- Construction is strengthened, thicker material with additional mounts, Materials used are well known SSAB quality Strenx 650 Mc, Strenx 700 Mc, with those materials we have achieved higher durability and as light weight as possible of the grapples. Lighter grapple makes excavator or forest machinery to wear out less.
- Grapples has additional fastener points where to attach any, specially adjusted coupling. Adapters should be fastened with screws - you can change and use it on different excavators and forest machinery.
- Except models DGE12 and DGE20, all other models have 2 reaction bars that contribute to stable and symmetrical performance of grapple as well as spread the load on cylinder that in long run decrease the wear of grapple.
- Short cylinder working track provides fast movement of the grapple - opening/closing.

MODEL		DGE12	DGE20	DGE25	DGE28	DGE35	DGE42	DGE55	
A	HEIGHT WHEN OPEN	mm	495	550	620	745	770	845	945
B	MAX OPENING	mm	1000	1250	1400	1435	1820	2000	2250
C	HEIGHT WHEN CLOSED	mm	350	425	480	530	610	620	730
D	MIN GRIPPING DIAMETER	mm	57	73	90	105	125	125	125
E	LENGTH WHEN CLOSED	mm	545	645	730	810	930	1045	1150
F	GRIPPING AREA	m ²	0,14	0,2	0,25	0,28	0,35	0,42	0,55
G	WIDTH	mm	264	325	405	420	485	490	600
H	MAX WIDTH	mm	264	335	410	430	495	500	620
WEIGHT		kg	56	88	145	195	275	290	500
MAX LOAD		kg	1500	2000	3500	3500	5000	5000	5000
MAX WORKING PRESSURE		Bar	200	250	250	250	250	250	250
CYLINDER FORCE		kN	35,3	71,6	115,5	115,5	146,2	180,5	196
GRIPPING FORCE ARMS TIP		kN	7	12,1	19,3	19,2	25,4	32,8	35
OPENING TIME 70L/MIN		s	0,16	0,28	0,62	0,5	0,8	1,3	1,5
CLOSING TIME 70L/MIN		s	0,24	0,46	0,83	0,9	1,3	1,8	2
ROTATOR DIRECT CONNECTION *			B	D	D	C	C	C	H
ORDER CODE			DGE12	DGE20	DGE25	DGE28	DGE35	DGE42	DGE55

* Please, see the rotator connection page for detailed information.

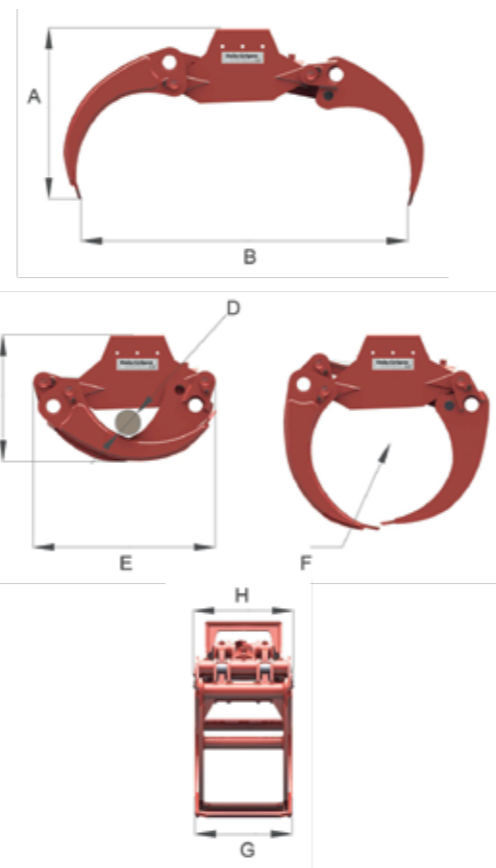

Powerful and durable, at the same time fast and flexible, universal for loading of stone, scrap and other waste. Massive heavy duty claws with enhancement as well as Hardox450 material are insurance of durability.

- Grapples has additional fastener points where to attach any, specially adjusted coupling. Adapters should be fastened with screws - you can change and use it on different excavators and forest machinery. Can be attached with standard forest machinery rotator and work like free hanging grapple.
- 2 reaction links that contribute to symmetrical performance of grapple and spread the load on cylinder that in long run decreases the wear of grapple.
- Short cylinder working track provides fast movement of the grapple - opening/closing.
- Descending knives made of Hardox450, knives are double side useable, if one side is worn out, turn around and you will have new knives.
- DGS39/42 with security valve as standard.

MODEL		DGS12	DGS20	DGS25	DGS28	DGS35	DGS39	DGS42	
A	HEIGHT WHEN OPEN	mm	430	470	530	625	730	925	1140
B	MAX OPENING	mm	835	1225	1440	1545	1765	1890	2355
C	HEIGHT WHEN CLOSED	mm	452	610	715	800	910	1040	1280
E	LENGTH WHEN CLOSED	mm	552	640	740	825	945	1125	1400
F	MAX WIDTH	mm	322	395	432	530	780	780	1080
H	GRIPPING AREA WIDTH	mm	375	390	470	530	610	762	955
I1	GRIPPING AREA HEIGHT	mm	237	335	410	460	555	660	825
I2	INSIDE HEIGHT OPENED 1 M	mm	-	325	430	500	635	755	950
I3	INSIDE HEIGHT MAX OPENED	mm	221	210	235	300	385	555	700
WEIGHT		kg	62	113	175	275	455	650	1025
MAX LOAD		kg	1500	3000	3500	3500	5000	5000	5000
MAX WORKING PRESSURE		Bar	200	250	250	350	350	350	350
CYLINDER FORCE		kN	35	78	116	175	222	275	332
GRIPPING FORCE ARMS TIP		kN	6,7	11	18	22,5	28	35	42
OPENING TIME 70L/MIN		s	0,16	0,28	0,60	0,45	0,8	1	1,6
CLOSING TIME 70L/MIN		s	0,24	0,48	0,83	0,9	1,3	1,6	2,3
ROTATOR DIRECT CONNECTION *			D	D	D	C	E	E	E
ORDER CODE			DGS12	DGS20	DGS25	DGS28	DGS35	DGS39	DGS42

* Please, see the rotator connection page for detailed information.

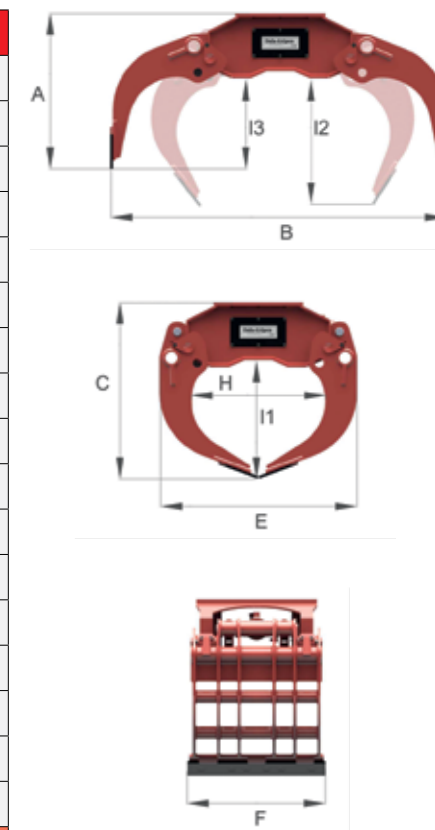

Multi grapple is suited for different waste sorting and pipe/round wood loading or moving. With multi grapple your work is more flexible without changing machinery - grab, load and even dig if you need so.

- Mainly used as sorting grapple. With specially designed knives (from Hardox 450) where one side is smooth and the other with tags, you can perform max preventing ground damages, turning knives around digging function is available.
- Special designed claws (with tags) catches hold to the material and decreases sliding options.
- With accessories (adjusting sides) grapple becomes as bucket and it is possible to load bulk - excellent for sand, gravel, pebbel etc.
- Grapples has additional fastner points where to attach any, specially adjusted coupling. Adapters should be fastened with screws - you can change and use it on differen excavators and forest machinery. Can be attached with standard forest machinery rotator and work like free hanging grapple.
- 2 reaction bars that contributes to stable and symmetrical performance of grapple as well as spread the load on cylinder that in long run decreases the wear of grapple.
- Short cylinder working track provides fast movement of the grapple - opening/closing.

MODEL		DGM20	DGM28	
A	HEIGHT WHEN OPEN	mm	470	625
B	MAX OPENING	mm	1225	1545
C	HEIGHT WHEN CLOSED	mm	610	800
E	LENGTH WHEN CLOSED	mm	685	860
F	MAX WIDTH	mm	590	740
H	GRIPPING AREA WIDTH	mm	360	370
I1	GRIPPING AREA HEIGHT	mm	320	455
I2	INSIDE HEIGHT OPENED 1 M	mm	325	500
I3	INSIDE HEIGHT MAX OPENED	mm	210	300
CAPACITY WHEN CLOSED		l	120	200
WEIGHT		kg	136	308
MAX LOAD		kg	3000	3500
MAX WORKING PRESSURE		Bar	250	350
CYLINDER FORCE		kN	77,8	175
GRIPPING FORCE ARMS TIP		kN	10,3	22,5
OPENING TIME 70L/MIN		s	0,28	0,7
CLOSING TIME 70L/MIN		s	0,48	0,9
ROTATOR DIRECT CONNECTION *			D	C
ORDER CODE			DGM20	DGM28

* Please, see the rotator connection page for detailed information.

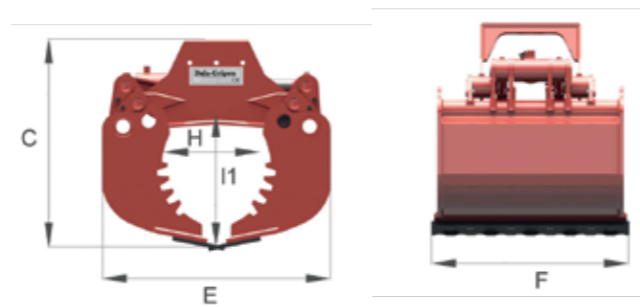
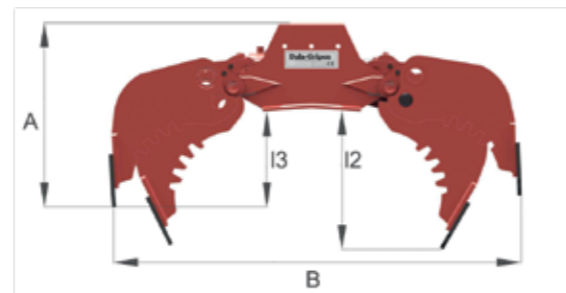

Round wood grapples that are fast and reliable. Everything that you need for smooth loading of timber on and off machines, with a high level of productivity. Rolling - in characteristics and opening speed ensures top quality handling.

- Standard grapple construction. Materials used are well known SSAB quality Weldox 700, Strenx 650 Mc, Strenx 700 Mc, with those materials we have achieved higher durability and as light weight as possible of the grapples. Lighter grapple makes excavator or forest machinery to wear out less.
- All connections are accordingly to all manufacturers standard rotator mount locations.
- Except models DG8, DG14, DG20 and DG22, all other models have 2 reaction bars that contributes to stable and symmetrical performance of grapple as well as spread the load on cylinder that in long run decreases the wear of grapple.
- Short cylinder working track provides fast movement of the grapple - opening/closing.

MODEL		DG8	DG12	DG14	DG20-1	DG20-2	DG22	DG25	DG28	DG29	DG35	DG36	DG42	DG55	
A	HEIGHT WHEN OPEN	mm	405	503	495	605	550	520	615	735	695	760	735	845	945
B	MAX OPENING	mm	865	1080	1000	1205	1250	1300	1400	1435	1560	1820	1730	2000	2250
C	HEIGHT WHEN CLOSED	mm	325	355	350	405	415	420	475	520	550	600	570	620	730
D	MIN GRIPING DIAMETER	mm	60	50	57	50	73	70	90	105	110	125	120	125	125
E	LENGTH WHEN CLOSED	mm	450	615	545	700	645	660	730	810	830	930	890	1045	1150
F	GRIPPING AREA	m ²	0,08	0,12	0,14	0,2	0,2	0,22	0,25	0,28	0,29	0,35	0,36	0,42	0,55
G	WIDTH	mm	220	200	260	310	280	364	375	420	420	485	472	490	600
H	MAX WIDTH	mm	220	270	260	400	295	364	390	430	488	495	540	500	620
WEIGHT		kg	25	46	45	77	68	88	125	170	240	250	280	290	500
MAX LOAD		kg	350	550	1200	1000	2000	2500	3500	3500	5000	5000	5000	5000	5000
MAX WORKING PRESSURE		Bar	180	200	200	250	250	250	250	250	250	250	250	250	250
CYLINDER FORCE		kN	35,3	35,3	35,3	72	71,6	71,6	115,5	115,5	146,2	146,2	180,5	180,5	196
GRIPPING FORCE ARMS TIP		kN	6,3	8,9	7	15	12,1	9	19,3	19,2	17,1	25,4	17,1	32,8	35
OPENING TIME 70L/MIN		s	0,14	0,19	0,16	0,44	0,28	0,4	0,62	0,5	0,9	0,8	1	1,3	1,5
CLOSING TIME 70L/MIN		s	0,2	0,3	0,24	0,66	0,46	0,6	0,83	0,9	1,5	1,3	1,6	1,8	2
ROTATOR DIRECT CONNECTION *			F	B	A	D	A	B	D	D	C	C	C	C	H
ORDER CODE			DG8	DG12	DG14	DG20-1	DG20-2	DG22	DG25	DG28	DG29	DG35	DG36	DG42	DG55

* Please, see the rotator connection page for detailed information.

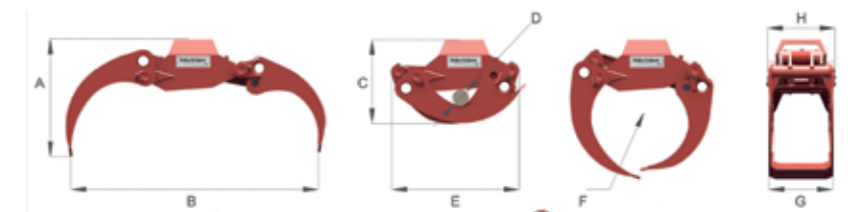

DG8 / 14 / 20 - 2

DG12 / 20 - 1

DG25 - 35 / 42 / 52

DG29 / 36

Grapples designed to take care of bushes, little sediment, twigs and branches. The claws are strong and flexible to make your performance fast and easy.

- Standard grapple construction. Materials used are well known SSAB quality Weldox 700, Strenx 650 Mc, Strenx 700 Mc, with those materials we have achieved higher durability and as light weight as possible of the grapples. Lighter grapple makes excavator or forest machinery to wear out less.
- All connections are accordingly to all manufacturers standard rotator mount locations.
- Except models DGR14, DGR20 and DGR22, all other models have 2 reaction bars that contributes to stable and symmetrical performance of grapple as well as spread the load on cylinder that in long run decreases the wear of grapple.
- Short cylinder working track provides fast movement of the grapple - opening/closing.

MODEL		DGR14	DGR20	DGR22	DGR25	DGR28	DGR29	DGR35	DGR36	DGR42	
A	HEIGHT WHEN OPEN	mm	495	415	520	500	570	695	610	735	680
B	MAX OPENING	mm	1000	1255	1300	1400	1475	1560	1810	1730	2000
C	HEIGHT WHEN CLOSED	mm	350	415	420	475	520	550	600	570	610
D	MIN GRIPING DIAMETER	mm	65	73	70	90	105	110	125	120	125
E	LENGTH WHEN CLOSED	mm	545	645	660	730	810	830	930	890	1045
F	GRIPPING AREA	m ²	0,14	0,2	0,22	0,25	0,28	0,29	0,35	0,36	0,42
G	WIDTH	mm	260	280	364	375	420	434	485	472	490
H	MAX WIDTH	mm	260	295	364	390	430	488	495	540	500
WEIGHT		kg	45	68	88	120	170	240	245	278	285
MAX LOAD		kg	1200	2000	2500	3500	3500	5000	5000	5000	5000
MAX WORKING PRESSURE		Bar	200	250	250	250	250	250	250	250	250
CYLINDER FORCE		kN	35,3	71,6	71,6	115,5	115,5	146,2	146,2	180,5	180,5
GRIPPING FORCE ARMS TIP		kN	7	12,1	9	19,3	19,2	25,4	17,1	32,8	
OPENING TIME 70L/MIN		s	0,16	0,28	0,4	0,62	0,5	0,9	0,8	1	1,3
CLOSING TIME 70L/MIN		s	0,24	0,46	0,6	0,83	0,9	1,5	1,3	1,6	1,8
ROTATOR DIRECT CONNECTION *			A	A	B	D	D	C	C	C	C
ORDER CODE			DGR14	DGR20	DGR22	DGR25	DGR28	DGR29	DGR35	DGR36	DGR42

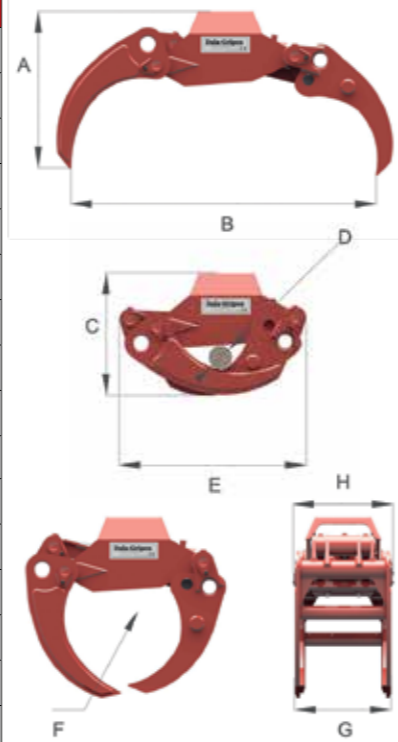

* Please, see the rotator connection page for detailed information.



DGR14 - 20

DGR25 - 42

DGR29 / 36

Clamshell buckets are made on the basis of our successful and proven to be durable design of standard grapple. Available in 3 most popular sizes, with optimal geometry and perfect construction. Clamshell buckets can be used on all machinery using the bracket.

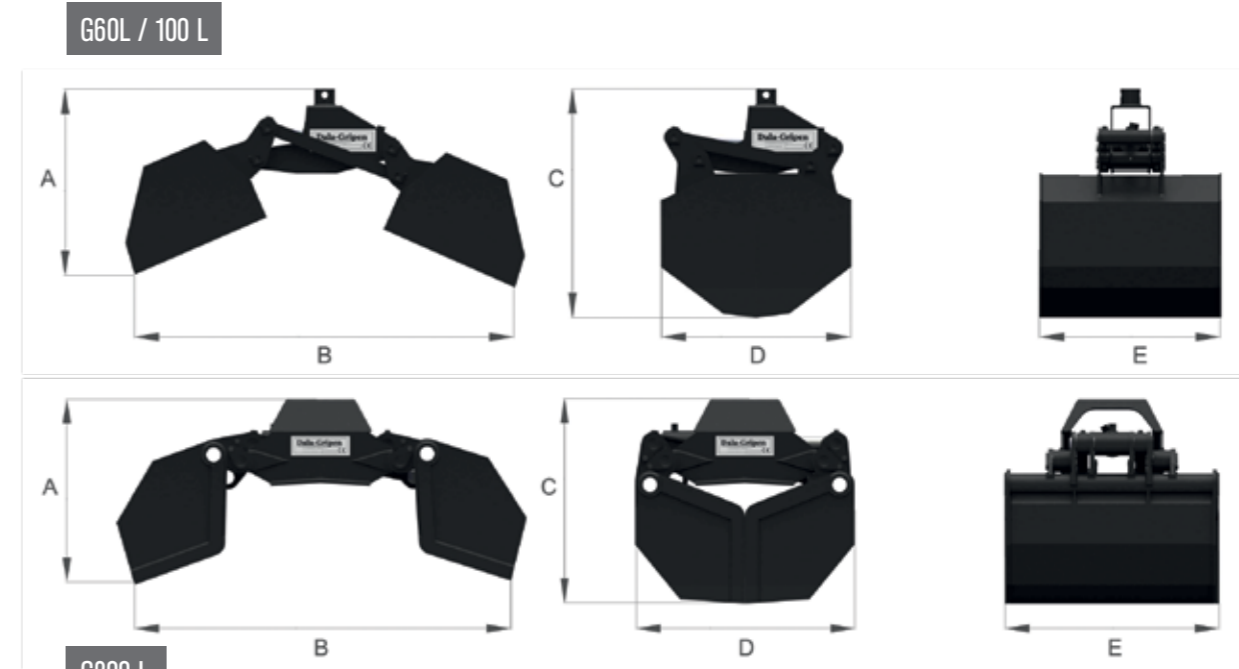

MODEL		G60L	G100L	G200L	
A	HEIGHT WHEN OPEN	mm	480	485	625
B	MAX OPENING	mm	1210	1335	1535
C	HEIGHT WHEN CLOSED	mm	650	715	760
D	LENGTH WHEN CLOSED	mm	500	580	820
E	MAX WIDTH	mm	406	550	790
CAPACITY		l	60	100	200
WEIGHT		kg	59	78	270
MAX LOAD		kg	500	600	2500
MAX WORKING PRESSURE		Bar	160	160	250
CYLINDER FORCE		kN	49,8	49,8	158,9
GRIPPING FORCE ARMS TIP		kN	8	8	19,2
OPENING TIME 70L/MIN		s	0,3	0,3	0,7
CLOSING TIME 70L/MIN		s	0,5	0,5	1,1
ROTATOR DIRECT CONNECTION *			F/G	F/G	C
ORDER CODE			G60L	G100L	G200L

* Please, see the rotator connection page for detailed information.



G60 L / 100 L

G200 L

With DALA-KLIPPEN energy wood gathering is more productive and profitable! Top quality product that allows you to be faster as movement track of the Energy wood grapple has been made precise. Excellent for cutting round wood up to 300mm as well as cutting bushes.

- Standard grapple construction. Materials used are well known SSAB quality Weldom 700, Strenx 650 Mc, HARDOX 450, with those materials we have achieved higher durability and as light weight as possible of the grapples. Lighter grapple makes excavator or forest machine to wear out less.
- Grapples has additional fastener points where to attach any, specially adjusted coupling. Adapters should be fastened with screws - you can change and use it on different excavators.
- Strong powerful cylinder that ensures safe cut of materials.
- Passive knife (screwed to the grapple) ensures fast work of excavator as there is no need of additional function during the cutting of wood.
- Passive Knife doesn't need any additional hydraulic connections from excavator.
- DGC250/ 300 with speed valve.

MODEL		DGC180	DGC180-K	DGC250	DGC300	
A	MAX OPENING	mm	700	700	680	840
B	GRAPPLE LENGHT WHEN CLOSED	mm	670	670	800	950
C	GRAPPLE WIDTH	mm	290	290	410	540
	WEIGHT	kg	185	210	270	570
	WORKING PRESSURE	Bar	180-250	180-250	250-300	250-300
	MIN OIL FLOW	l/min	25	25	60	90
	SINGLE CUT	Ømm	150-180	150-180	250	300
	ROTATOR DIRECT CONNECTION *	Brackets	D	Brackets	Brackets	
	ORDER CODE	DGC180	DGC180-K	DGC250	DGC300	

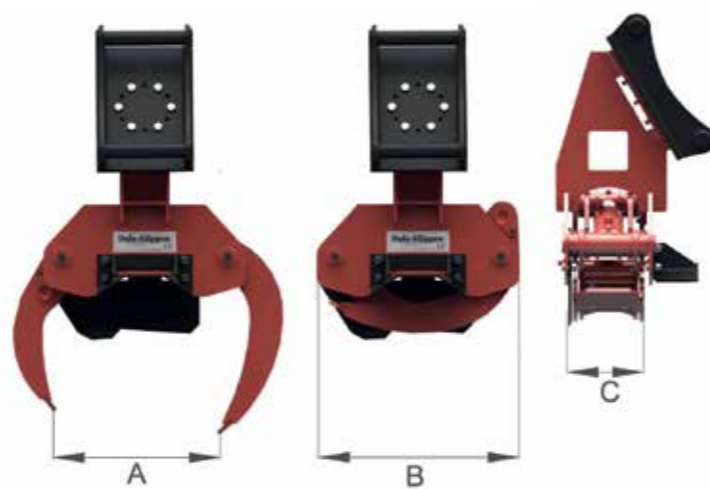

* Please, see the rotator connection page for detailed information.



- Increases harvesting capacity by 75% and thus giving a lower cost.
- Possible to mount to Dala- Klippen.
- Dala-Acc should mounts on the clipper that is used with rotortilt.
- It is powered by a four-hose rotor or alternate valve. There must be a leak-free oil line with a free return and a power cord for the gear valve.
- Can be used on DGC250 and DGC300.

MODEL		ACC	
A	WIDTH WHEN CLOSED	mm	755
B	DEPTH WHEN CLOSED	mm	340
C	MAX OPENING	mm	1120
D	HEIGHT	mm	275
	WEIGHT	kg	98
	MATERIAL HOLDING AREA	m ²	0,07
	WORKING PRESSURE	Bar	80-120
	OIL FLOW	l/min	20-60
	OPENING TIME 20L/MIN	s	0,5
	CLOSING TIME 20L/MIN	s	0,3
	ORDER CODE	ACC	

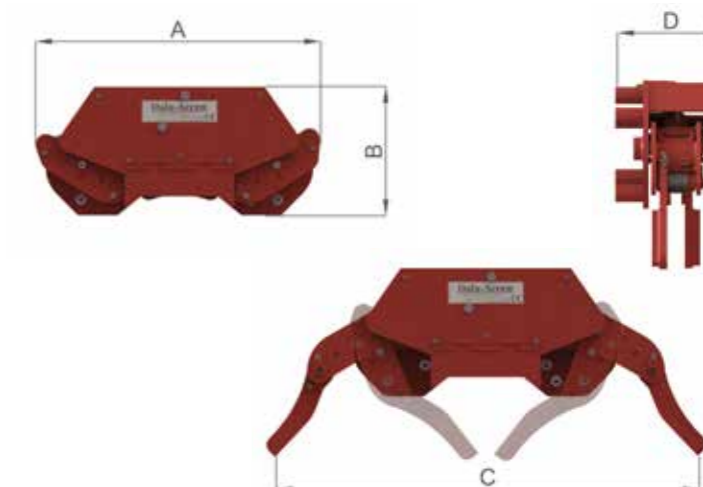

DGC180



DGC180-K



DGC250



DGC300





S60

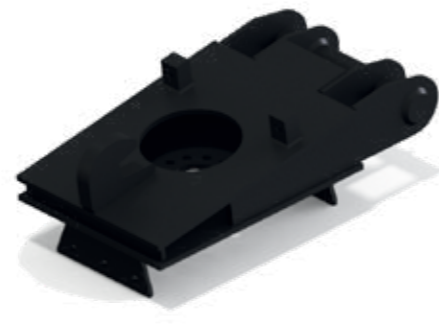

B20

EXCAVATOR WEIGHT/ADAPTER BRACKETS					
0,5-2 TON	1,5-6 TON	6-12 TON	10-19 TON	18-23 TON	26-40 TON
MS01	MS03	MS08	MS10	MS21	MS25
DGE12	DGE12	DGE20	DGE28	DGE35	DGE55
DGE20	DGE20	DGE25	DGE35	DGE42	DGS39
DGS12	DGE25	DGE28	DGE42	DGE55	DGS42
	DGS12	DGE35	DGE55	DGS35	
	DGS20	DGS20	DGS28	DGS39	
	DGS25	DGS25	DGS35	DGS42	
	DGM20	DGS28	DGS39		
		DGM20	DGM28		
		DGM28			

EXCAVATOR WEIGHT/ADAPTER BRACKETS						
0,5-1 TON	1-3,5 TON	3-10,5 TON	7-15 TON	15-20 TON	20-27 TON	25-45 TON
CW-00	CW-05	CW-10	CW-20	CW-30	CW-40	CW-45
DGE12	DGE12	DGE12	DGE25	DGE35	DGE35	DGE55
DGS12	DGE20	DGE20	DGE28	DGE42	DGE42	DGS39
	DGS12	DGE25	DGE35	DGE55	DGE55	DGS35
	DGS20	DGE28	DGE42	DGS28	DGS35	
	DGM20	DGS12	DGE55	DGS35	DGS39	
		DGS20	DGS25	DGS39	DGS42	
		DGS25	DGS28	DGS42		
		DGM20	DGS35			
			DGM28			

EXCAVATOR WEIGHT/ADAPTER BRACKETS							
1-2 TON	2-6 TON	6-11 TON	11-18 TON	18-24 TON	18-30 TON	22-32 TON	30-40 TON
S30/150	S40	S45	S60	B20 (S1)	S70	B27 (S2)	S80
S30/180		S50					
DGE12	DGE12	DGE20	DGE28	DGE35	DGE35	DGE35	DGE55
DGE20	DGE20	DGE25	DGE35	DGE42	DGE42	DGE42	DGS39
DGS12	DGE25	DGE28	DGE42	DGE55	DGE55	DGE55	DGS42
	DGS12	DGE35	DGE55	DGS28	DGS35	DGS35	
	DGS20	DGS20	DGS28	DGS35	DGS39	DGS39	
	DGS25	DGS25	DGS35	DGS39	DGS42	DGS42	
	DGM20	DGS28	DGS39	DGS42			
		DGM20	DGM28				
		DGM28					



MS03 / DGE 25



MS03 / DGS 20



S45 / DGS 20



S45 / DGE 25

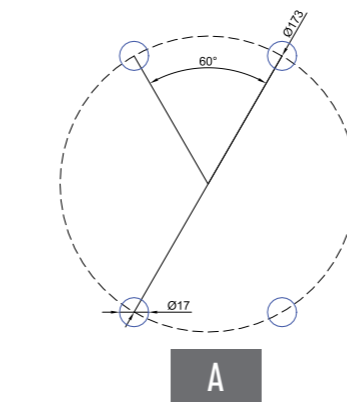

A

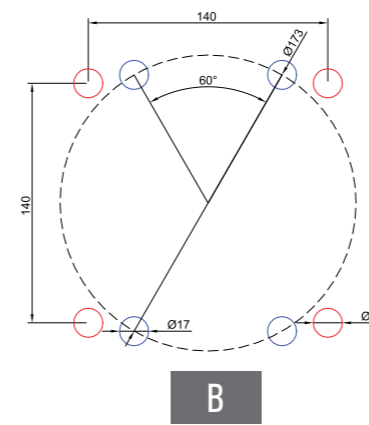

B

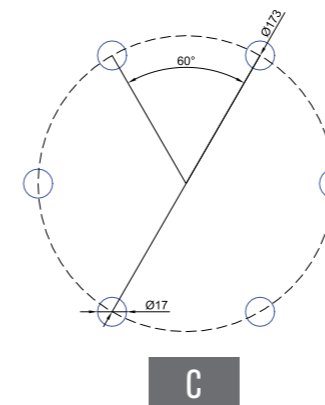

C

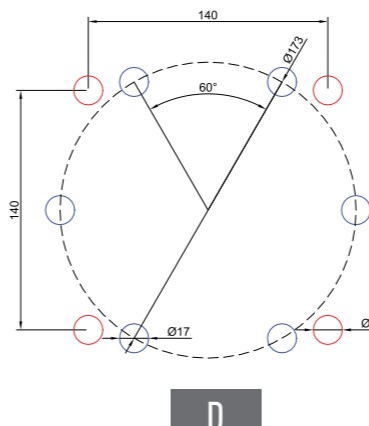

D

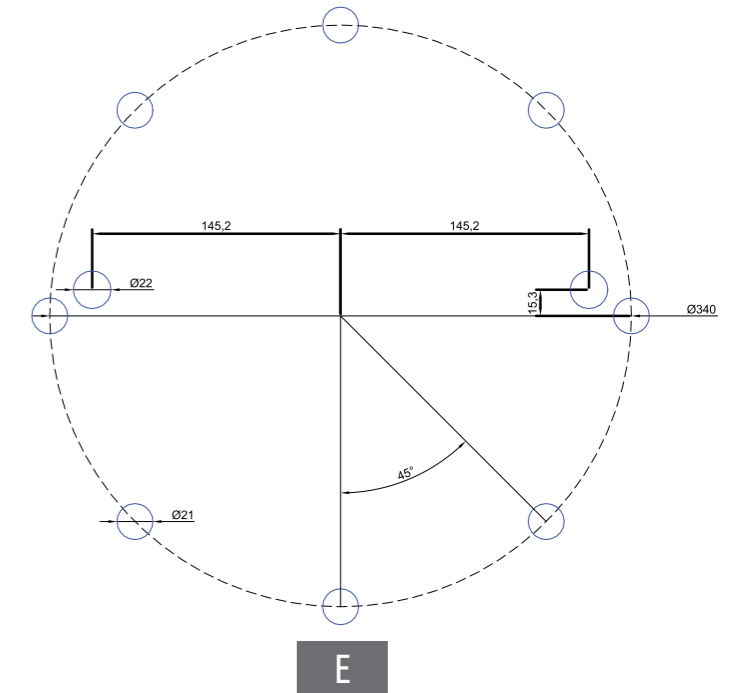

E

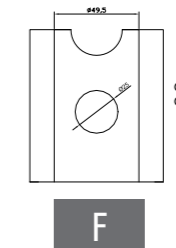

F

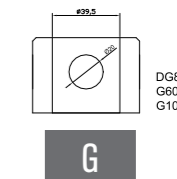

G

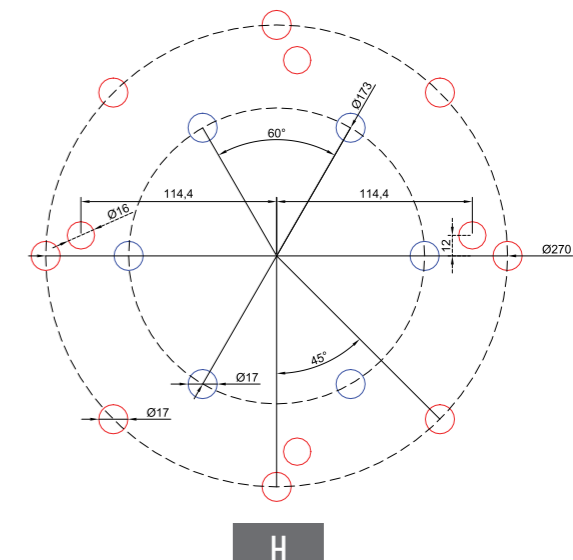

H

***SIT*RIGHT**

— NUMBER ONE IN THE FOREST —

Närsjövägen 36,
SE-78053 NÅS, Sweden
E-mail: mail@sit-right.se
Phone: +46 2813 0030
www.sit-right.se